

## Eccentrico Ø 15 senza bordo

## Cam Ø 15 wo/rim

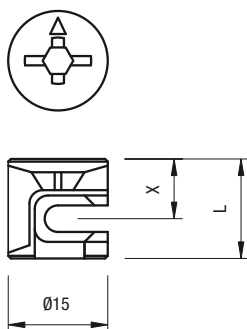

	ART.	$\nabla/\triangle$	Ø	L	X	
Zama	<b>202</b>	16	15	13	8	2.000
	<b>203</b>	18-20	15	15	9-10	2.000
	<b>205</b>	22	15	17	11	2.000
	<b>206</b>	25	15	18	12,5	2.000
	<b>207</b>	30	15	20	14,5	2.000

## Eccentrico Ø 15 con bordo

## Cam Ø 15 w/rim

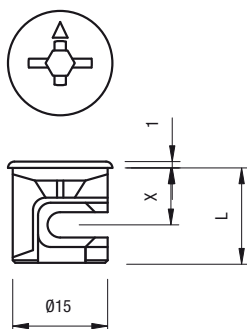

	ART.	$\nabla/\triangle$	Ø	L	X	
Zama	<b>212</b>	16	15	13	8	2.000
	<b>213</b>	18-20	15	15	9-10	2.000
	<b>215</b>	22	15	17	11	2.000
	<b>216</b>	25	15	18	12,5	2.000
	<b>217</b>	30	15	20	14,5	2.000

## Eccentrico Ø 15 "leggero" con/senza bordo

## Cam Ø 15 "light" w/wo rim

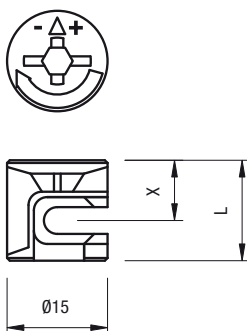

senza bordo						wo/rim
	ART.	$\nabla/\triangle$	Ø	L	X	
Zama	<b>150</b>	13	15	10	6,50	4.000
	<b>151</b>	14	15	10,5	7	4.000
	<b>152</b>	16	15	12	8	4.000
	<b>153</b>	18	15	13,5	9	4.000
con bordo						w/rim
	ART.	$\nabla/\triangle$	Ø	L	X	
	<b>161</b>	14	15	10,5	7	4.000

## Eccentrico Ø 12

Cam Ø 12

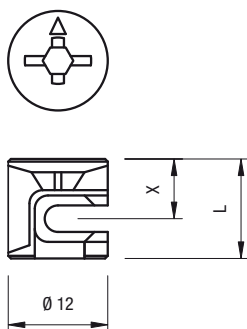

### senza bordo

wo/rim

ART.	Ø	L	X	
Zama <b>166</b>	10	9,5	5	2.500
<b>167</b>	12	10,5	6	2.500

### con bordo

w/rim

ART.	Ø	L	X	
<b>165</b>	12	10,5	6	2.500

## Cover

Cover

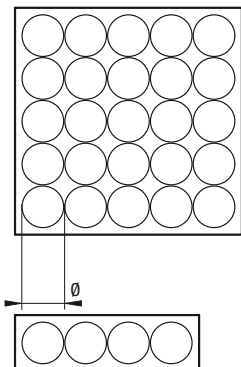

ART.	Ø	pz. per tessera pcs for set	
<b>5401</b>	9	60	6.000
<b>5402</b>	13	20	5.000
<b>5403</b>	14	25	5.000
<b>5404</b>	17,6	16	4.000
<b>5405</b>	20	15	1.800
<b>5406</b>	24	12	1.200
<b>5407</b>	40	2	1.000

## Copri eccentrico Ø 17

Cover cap Ø 17

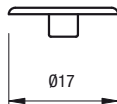

ART.	Ø	Colore / Colour	
Nylon <b>220</b>	17	A richiesta / On request	10.000

## Tirante con anelli 6MA / FL6

## Dowel with rings 6MA / FL6

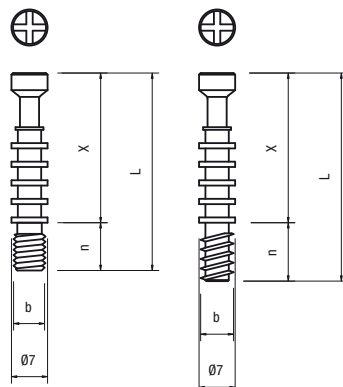

	ART.	Ø	L	b	X	n	
Acciaio	<b>231</b>	7	28	6MA	20	9	4.000
	<b>232</b>	7	32	6MA	24	9	4.000
	<b>233</b>	7	35	FL6	24	11	4.000
	<b>242</b>	7	36	6MA	28	9	2.000
	<b>243</b>	7	39	FL6	28	11	2.000
	<b>252</b>	7	42	6MA	34	9	2.000
	<b>253</b>	7	45	FL6	34	11	2.000

## Tirante zigrinato 6MA / FL6

## Dowel with cross 6MA / FL6

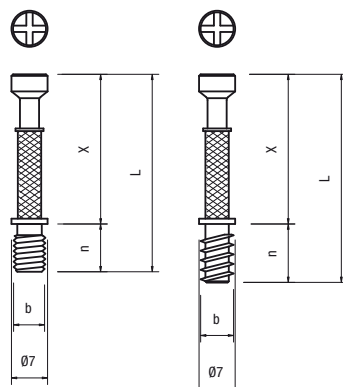

	ART.	Ø	L	b	X	n	
Acciaio	<b>234</b>	7	32	6MA	24	9	4.000
	<b>235</b>	7	35	FL6	24	11	4.000
	<b>244</b>	7	36	6MA	28	9	2.000
	<b>245</b>	7	39	FL6	28	11	2.000
	<b>254</b>	7	42	6MA	34	9	2.000
	<b>255</b>	7	45	FL6	34	11	2.000

## Tirante stampato 6MA / FL6

## Pressed dowel 6MA / FL6

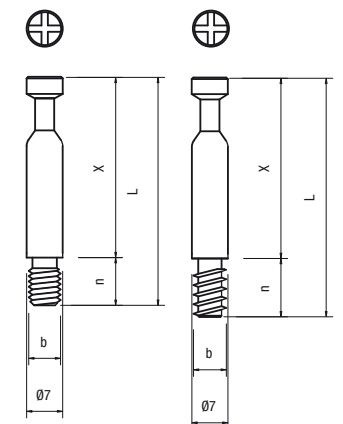

	ART.	Ø	L	b	X	n	
Acciaio	<b>292</b>	7	32	6MA	24	9	2.000
	<b>293</b>	7	35	FL6	24	11	2.000
	<b>294</b>	7	36	6MA	28	9	2.000
	<b>295</b>	7	39	FL6	28	11	2.000
	<b>296</b>	7	42	6MA	34	9	2.000
	<b>297</b>	7	45	FL6	34	11	2.000

## Tirante tornito 6MA

## Turned dowel 6MA

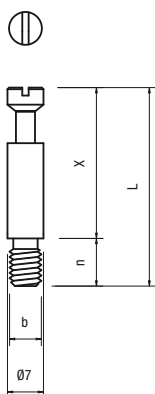

	ART.	Ø	L	b	X		
Acciaio	<b>112</b>	7	32	6MA	24	2.000	
	<b>114</b>	7	36	6MA	28	2.000	
	<b>116</b>	7	42	6MA	34	2.000	
		7	A disegno / On drawing				

## Tirante espansione

## Expanding dowel

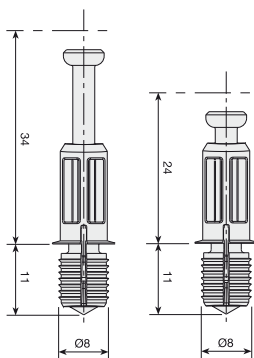

	ART.	Ø	L	b	X	
Acciaio + Nylon	<b>118</b>	7	32	6MA	24	2.000
	<b>119</b>	7	42	6MA	34	2.000

## Tirante doppio senza anello

## Double-ended dowel w/o ring

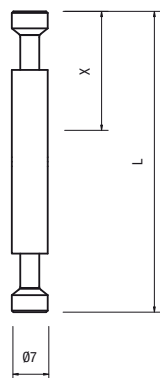

	ART.	Ø	L	X		
Acciaio	<b>261</b>	7	48	24	0	1.000
	<b>262</b>	7	68	34	0	1.000
	<b>263</b>	7	53	24	5	1.000
	<b>264</b>	7	64	24	16	1.000
	<b>265</b>	7	84	34	16	1.000
	<b>266</b>	7	67	24	19	1.000
	<b>267</b>	7	87	34	19	1.000
	7	A disegno / On drawing				

## Tirante doppio con anello

## Double-ended dowel w/ring

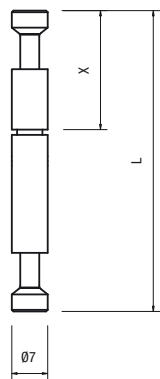

	ART.	Ø	L	X		
Acciaio	<b>274</b>	7	64	24	16	1.000
	<b>275</b>	7	84	34	16	1.000
	<b>276</b>	7	67	24	19	1.000
	<b>277</b>	7	87	34	19	1.000
	7	A disegno / On drawing				

## Tirante tornito 90°

## Double-ended dowel 90°

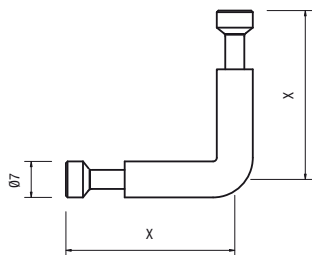

	ART.	Ø	X		
Acciaio	<b>272</b>	7	34	fisso 90°	1.000
	<b>273</b>	7	44	snodato 45° - 180°	1.000

## Eccentrico Ø 25

Cam Ø 25

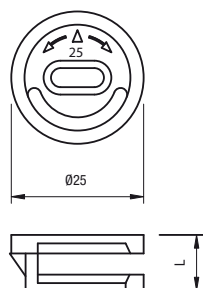

	ART.	Ø	L	
Zama	<b>101</b>	25	11	2.000
	<b>102</b>	25	12	2.000
	<b>103</b>	25	13	2.000

## Copri eccentrico Ø 30

Cover cap Ø 30

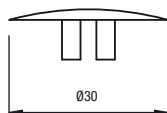

	ART.	Ø	L	Colore / Colour	
Nylon	<b>131</b>	30	9	A richiesta / On request	2.000
	<b>132</b>	30	14	A richiesta / On request	2.000

## Eccentrico spirale Ø 35

## Spiral cam Ø 35

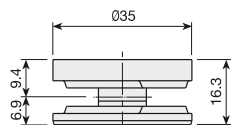

	ART.	$\frac{\Delta}{\Delta}$	L	X	
Zama	<b>171</b>	18/40	16,3	9,4	500

## Tirante spirale Ø 8,5

## Spiral dowel Ø 8,5



	ART.	Ø	L	X	n	b	
Acciaio	<b>181</b>	8,5	39	16	11	8MA	1.000
	<b>182</b>	8,5	37	16	9	6MA	1.000
	<b>183</b>	8,5	59	36	11	8MA	1.000
	<b>184</b>	8,5	57	36	9	6MA	1.000

## Copri eccentrico Ø 37

## Cover cap Ø 37

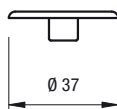

	ART.	Ø	Colore / Colour	
Nylon	<b>191</b>	37	A richiesta / On request	500